

RDC-4X4-16C

Dimensions w/ intake(s): 115D" x 94W" x 135H"

Base Weight: 7,033 lbs.

Includes base collector, HLL & intake(s)

Equipment

Video Link

Controls: ePro 7" touchscreen for ease of use.



Heavy Duty Construction: Fully welded 7 & 11 gauge steel



Pulsing System: 20 SCFM



Filter Design: Included as standard to improve filter life and reduce energy consumption



Blower/Motor Combination: designed for energy efficiency

SafeSensor Particulate Monitor: detects leaks past the filters



Air Intake: reduces airspeed allowing heavy dust to fall away from filters

Warranty: 15 years on the cabinet; 5 years on components *(See warranty document for details)*

Fire Suppression (optional): FM-200, CO₂, water



Built-in Stack Silencer (optional): for quiet operation

After Filters (optional): HEPA or active carbon



Explosion Vent (optional): part of a complete NFPA package



Specifications

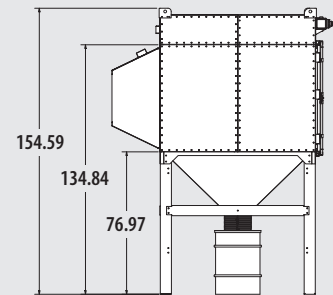
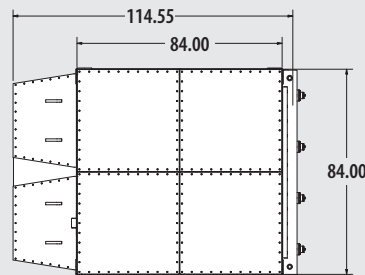
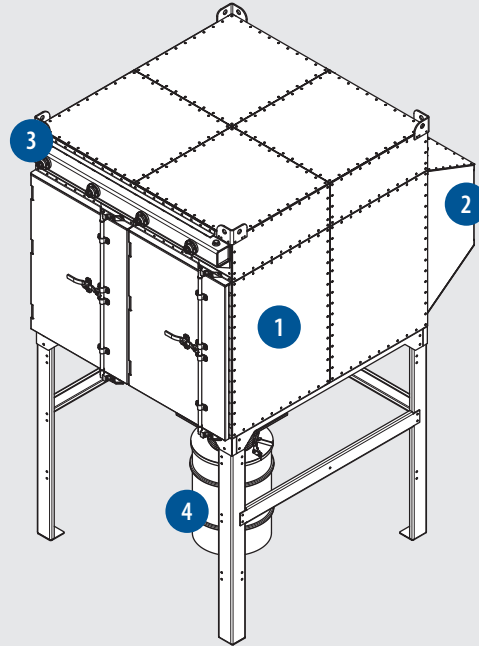

- 1 Filter Cabinet Assembly
- 2 Air Intake
- 3 Advanced Pulsing System
- 4 Dust Containment Bin
- 5 SafeSensor Particulate Monitor

Part No.

Qty.

Configuration

CFM @ "SP"

PL A:C

EX A:C

Motor

SH-10-1708-ALM-3550-TM	(1)	10 HP • 17 @ 100%	2,000 @ 15.0	N/A	0.6:1
SH-15-2048-ACF-3550-TM	(1)	15 HP • 20 @ 48%	4,000 @ 15.0	0.5:1	1.2:1
SH-25-2084-ACF-3550-TM	(1)	25 HP • 20 @ 84%	7,000 @ 15.0	0.9:1	2.1:1
SH-40-2272-ACF-3550-TM	(1)	40 HP • 22 @ 72%	10,000 @ 15.0	1.3:1	3.0:1
SH-50-2286-ACF-3550-TM	(1)	50 HP • 22 @ 86%	12,000 @ 15.0	1.6:1	3.6:1
SH-75-2476-PLR-3550-TM	(1)	75 HP • 24 @ 76%	18,000 @ 15.0	2.4:1	N/A
SH-75-4061-ACF-1880-TM	(1)	75 HP • 40 @ 61%	24,000 @ 15.0	3.2:1	N/A

**(Usable static)*

Required Selections	Item Description
Intake Options	
RDC-IT-04	Senturion 4 Wide Standard Intake
RDC-AB-04	Senturion 4 Wide Abrasive Intake*
*Must mount on IT Standard Intake	
Containment Options	
RDC-HSL-4X4-16C	Senturion 16-Cartridge 20-Gal Hopper & Legs (adds 59" to base height)
RDC-HLL-4X4-16C	Senturion 16-Cartridge 55-Gal Hopper & Legs (adds 77" to base height)
Filter Option	
PL-14D52-M11-SF21-16	Pleatlock M11 Cartridge Filters (MERV 11)
PL-14D52-A15-SF21-16	Pleatlock A15 Cartridge Filters (Nano MERV 15)
EX-14D52-B16-SF21-16	Endurex B16 Cartridge Filters (PTFE MERV 16)
Controls Mounting	
RDC-CTRL-GM	Ground Mounted Control Panel
RDC-CTRL-CM	Collector Mounted Control Panel
RDC-CTRL-WM	Wall Mounted Control Panel
480v & 575v Whip Options (1 Required per Motor)	
15' & 30' Length Available	

Options	Item Description
After Filters	
RDC-HEPA-4X4	Senturion 16-Cartridge Top Mount Pre-Blower HEPA Filter (adds 40" to base collector height)
RDC-CARBON-4X4	Senturion 16-Cartridge Top Mount Post-Blower Carbon Filter
Fire Suppression	
RDC-SPKLR-4X4-16C	Water Sprinkler System
RDC-CO2-4X4-16C-ID	CO ₂ System w/ Intake Damper
RDC-CO2-4X4-16C	CO ₂ System w/out Intake Damper
RDC-FM200-4X4-16C-ID	FM200 Fire Suppression System w/ Intake Damper
RDC-FM200-4X4-16C	FM200 Fire Suppression System w/out Intake Damper
Service Platform	
Senturion 4-Wide Service Platform (Includes rails, gate(s) and ladder)*	
*Adds 65" to door side of collector	
NFPA Options	
ST1 NFPA Standard Package*	
ST2 NFPA Standard Package*	
*Requires selection of HLL option. Includes RAL, explosion vents & controls	
Options and Upgrades	
CMR-20	AutoSaver Sensor
SSG-DTS	SuperSeal Hopper Gate
BLS-110	Barrel Sensor (requires RDC-CTRL-EX)
RDC-CTRL-EX	Controls Expansion Module (required for BLS or summer/winter dampers)

Additional Resources and Downloads (click image to retrieve material)



Owner's Manual

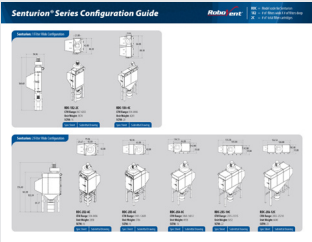

Equipment Configurations



Product Video

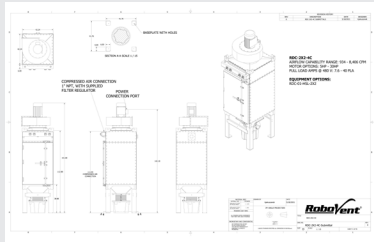

Submittal Drawing